



ParaMedical Labels

of Coos...kamonga, Inc.

(530) 626-5741 • (800) 622-7009 • FAX (530) 626-1808

P.O. Box 199000 • Diamond Springs, CA 95619

getlabels@paramedicallabels.com

Creating Your Own Custom Label

Steps:

1. Choose a size & shape.
2. Decide on ink color: red, blue or black.
3. Create your own unique label, or choose from one of our sample Rx labels shown under the Custom Labels & Cards dropdown menu. You can modify the layout to fit your hospital's needs.
4. Pick out a stock logo...*or send us your custom logo!*

Example Pricing:

R-9: \$62.00 per
roll of 1000

One-time

plate charge: \$18

Stock Logo: no charge

Total: \$80.00

*Our graphic artist
will send you a proof
prior to printing!*

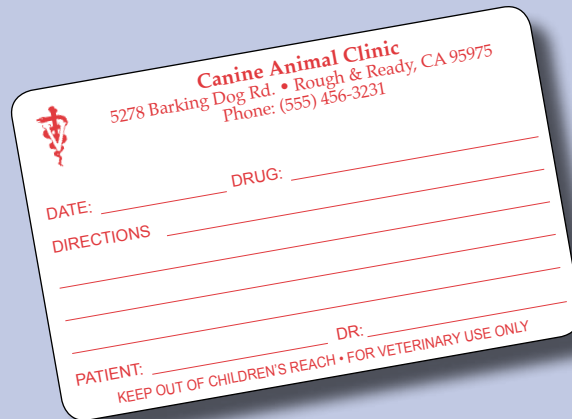

Example:

Size: R-9

Shape: Rectangle

Color: Red

Directions: #19

Logo: #002

Prices are for custom printed labels on white, non-glossy, pressure sensitive label paper with one ink color (your choice of red, blue or black). For custom colors or larger quantities, call for a price quote.

FOR 2-3 INK COLORS (Minimum order of 3,000): Add 30% for each additional color up to a total of 3 ink colors. Add \$11.00 to printing plate charge for each additional color.

SPECIALTY PAPER: Add 30% to price list for fluorescent paper color, Gold or Silver Foil paper, Clear Mylar and Vinyl stock. Add 20% for Laminating.

ONE-TIME PRINTING PLATE CHARGE (per label copy): Your label is printed using a one-piece plate. Any change requires remaking the whole plate. See printing plate charges below. Note: Plates not used for 3 years may be discarded and new printing plate fee charged. Orders cancelled after the label has been designed for proofing will be charged printing plate fee.

PRICE BREAKS: Price breaks for 3,000, 5,000 or 10,000 labels are for the SAME label copy in one continuous run.

LABEL DESIGN: You may choose from multiple "directions" as illustrated in our catalog or you may design your own label. Rx labels are printed with your hospital name and/or doctor's name, address, phone number and website if requested.

TURN-AROUND TIME: Repeat custom orders shipped in 5 business days, new custom orders 10 business days or by special arrangement.

CUSTOM PRINTED PRICE LIST

RECTANGLES	SIZE (inches)	PER 1,000	PER 3,000	PER 5,000	PER 10,000	Printing Plate Charge	Printing Plate w/Custom Logo
R-1	1 1/2" x 3 1/8"	\$36.00	\$33.00/k = \$99.00	\$28.00/k = \$140.00	\$22.00/k = \$220.00	\$13.00	\$29.00
R-2	1 3/4" x 7 1/8"	\$42.00	\$38.00/k = \$114.00	\$33.00/k = \$165.00	\$26.00/k = \$260.00	\$13.00	\$29.00
R-3	2 1/2" x 7 1/8"	\$47.00	\$41.00/k = \$123.00	\$36.00/k = \$180.00	\$26.00/k = \$260.00	\$13.00	\$29.00
R-4	3 1/2" x 3 1/4"	\$50.00	\$46.00/k = \$138.00	\$39.00/k = \$195.00	\$31.00/k = \$310.00	\$13.00	\$29.00
R-5	3" x 1"	\$55.00	\$48.00/k = \$144.00	\$41.00/k = \$205.00	\$33.00/k = \$330.00	\$13.00	\$29.00
R-6	2" x 1 1/2"	\$53.00	\$48.00/k = \$144.00	\$41.00/k = \$205.00	\$33.00/k = \$330.00	\$13.00	\$29.00
R-7	2 1/2" x 1 1/4"	\$53.00	\$48.00/k = \$144.00	\$41.00/k = \$205.00	\$33.00/k = \$330.00	\$13.00	\$29.00
R-8	2 1/2" x 1 1/2"	\$58.00	\$52.00/k = \$156.00	\$45.00/k = \$225.00	\$36.00/k = \$360.00	\$18.00	\$35.00
R-9	2 3/4" x 1 3/4"	\$62.00	\$57.00/k = \$171.00	\$48.00/k = \$240.00	\$38.00/k = \$380.00	\$18.00	\$35.00
R-10	3" x 2"	\$70.00	\$63.00/k = \$189.00	\$53.00/k = \$265.00	\$42.00/k = \$420.00	\$18.00	\$35.00
R-11	4" x 2"	\$78.00	\$70.00/k = \$210.00	\$59.00/k = \$295.00	\$47.00/k = \$470.00	\$24.00	\$40.00
R-12	4" x 2 1/2"	\$89.00	\$80.00/k = \$240.00	\$68.00/k = \$340.00	\$53.00/k = \$530.00	\$24.00	\$40.00
R-15	5" x 3"	\$110.00	\$99.00/k = \$297.00	\$84.00/k = \$420.00	\$67.00/k = \$670.00	\$29.00	\$46.00
SQUARES							
S-2	4" x 4"	\$112.00	\$102.00/k = \$306.00	\$91.00/k = \$455.00	\$78.00/k = \$780.00	\$29.00	\$46.00
OVALS							
O-1	1 1/4" x 3 1/4"	\$36.00	\$33.00/k = \$99.00	\$28.00/k = \$140.00	\$22.00/k = \$220.00	\$13.00	\$29.00
O-3	1 1/2" x 1"	\$42.00	\$38.00/k = \$114.00	\$33.00/k = \$165.00	\$26.00/k = \$260.00	\$13.00	\$29.00
CIRCLE							
C-1	3/4"	\$36.00	\$33.00/k = \$99.00	\$28.00/k = \$140.00	\$22.00/k = \$220.00	\$13.00	\$29.00
C-2	1"	\$42.00	\$38.00/k = \$114.00	\$33.00/k = \$165.00	\$26.00/k = \$260.00	\$13.00	\$29.00
C-3	1 1/2"	\$53.00	\$48.00/k = \$144.00	\$36.00/k = \$180.00	\$33.00/k = \$330.00	\$13.00	\$29.00
C-4	2"	\$58.00	\$52.00/k = \$156.00	\$45.00/k = \$225.00	\$36.00/k = \$360.00	\$18.00	\$35.00
C-5	2 3/4"	\$62.00	\$57.00/k = \$171.00	\$48.00/k = \$240.00	\$39.00/k = \$390.00	\$18.00	\$35.00















PIN FEED	SIZE (inches)	BACKING PAPER WIDTH	ROLL OF 1,000	3 ROLLS OF 1,000 = 3,000	5 ROLLS OF 1,000 = 5,000	10 ROLLS OF 1,000 = 10,000	Printing Plate Charge	Printed with Your Custom Logo
CP-3	2 1/2" x 7 1/8"	3 1/2" *	\$52.00	\$47.00/k = \$141.00	\$42.00/k = \$210.00	\$38.00/k = \$380.00	\$13.00	\$29.00
CP-7	2 1/2" x 1 1/4"	3 1/2" *	\$60.00	\$55.00/k = \$165.00	\$49.00/k = \$245.00	\$44.00/k = \$440.00	\$13.00	\$29.00
CP-9	2 3/4" x 1 7/16"	3 1/2" *	\$70.00	\$62.00/k = \$186.00	\$56.00/k = \$280.00	\$50.00/k = \$500.00	\$18.00	\$35.00
CP-95	2 3/4" x 1 3/4"	3 1/2" *	\$73.00	\$67.00/k = \$201.00	\$60.00/k = \$300.00	\$55.00/k = \$550.00	\$18.00	\$35.00
CP-10	3 1/4" x 1 7/8"	4 1/2" *	\$80.00	\$71.00/k = \$213.00	\$64.00/k = \$320.00	\$58.00/k = \$580.00	\$18.00	\$35.00
CP-14	4" x 2 7/8"	4 1/2" *	\$106.00	\$95.00/k = \$285.00	\$85.00/k = \$425.00	\$72.00/k = \$720.00	\$24.00	\$40.00

*Need extra backing paper width on your Computer Label? Add \$2.00 per inch, per thousand. For blank labels, deduct 50% off price list.

CUSTOM PRINTED THERMAL LABELS

THERMAL LABELS	SIZE (inches)	2 ROLLS OF 500 = 1000	6 ROLLS OF 500 = 3,000	10 ROLLS OF 500 = 5,000	20 ROLLS OF 500 = 10,000	Printing Plate Charge	Your Custom Logo
TL-10	2 3/4" x 1 3/4"	\$79.00	\$35.50 ea = \$ 213.00	\$32.00 ea = \$320.00	\$29.00 ea = \$580.00	\$12.25	\$28.50
TL-20	2 3/4" x 2 1/8"	\$79.00	\$35.50 ea = \$ 213.00	\$32.00 ea = \$320.00	\$29.00 ea = \$580.00	\$12.25	\$28.50
TL-35	3 1/16" x 1 13/16"	N/A	\$35.50 ea = \$ 213.00	\$32.00 ea = \$320.00	\$29.00 ea = \$580.00	\$12.25	\$28.50
THERMAL LABELS	SIZE (inches)	4 ROLLS OF 400	8 ROLLS OF 400 = 3,200	12 ROLLS OF 400 = 4,800	24 ROLLS OF 400 = 9,600	Printing Plate Charge	Your Custom Logo
TL-45	3 1/2" x 1 15/16"	N/A	\$34.50 ea = \$276.00	\$31.25 ea = \$375.00	\$28.00 ea = \$672.00	\$12.25	\$28.50

STOCK LOGOS

 VCA	 001	 002	 003	 004	 005	 006	 007	 008
 009	 010	 011	 012	 013	 014	 015	 016	

Choose from these available shapes and sizes!

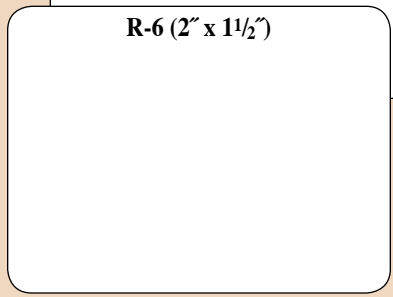
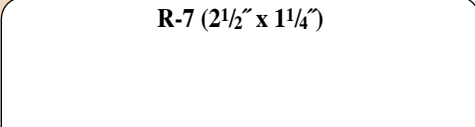
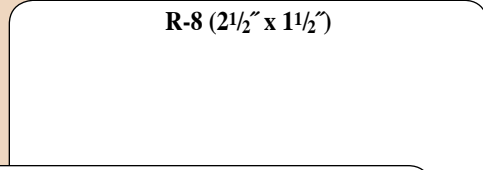
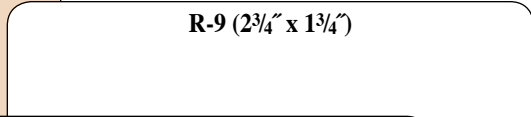
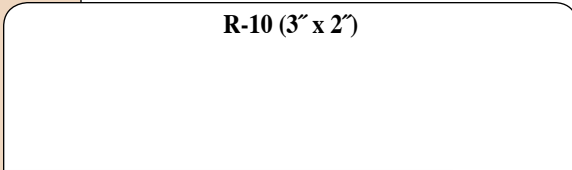
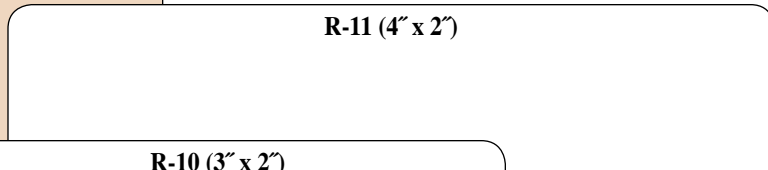
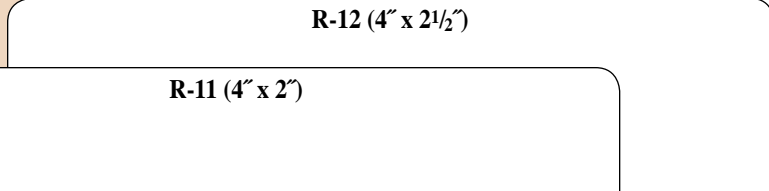
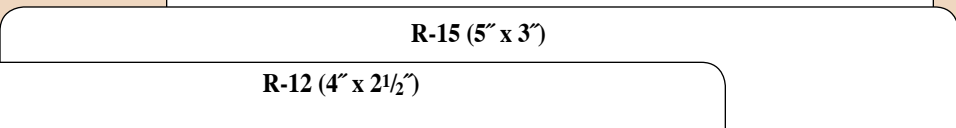
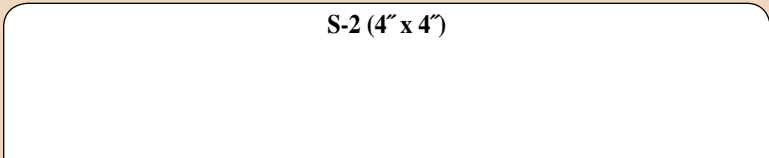

Thermal Labels

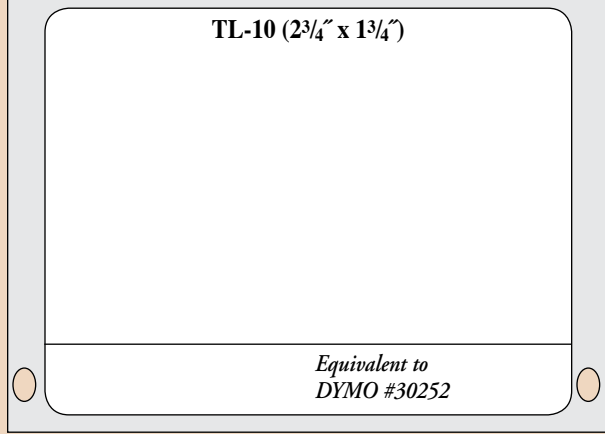
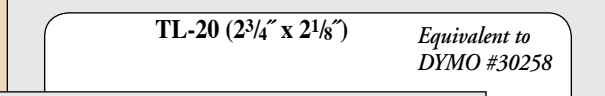
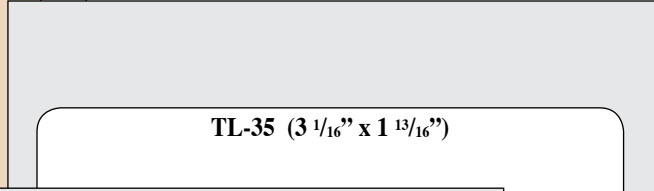
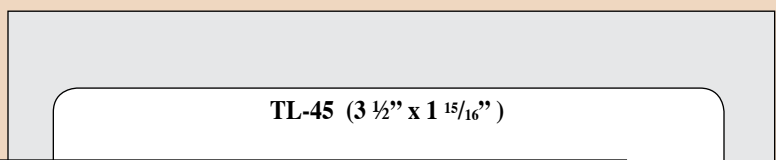

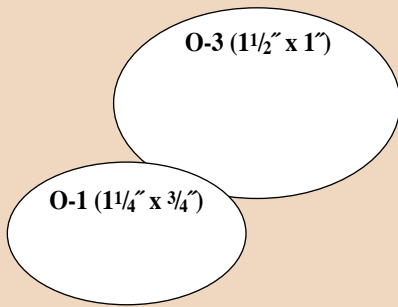
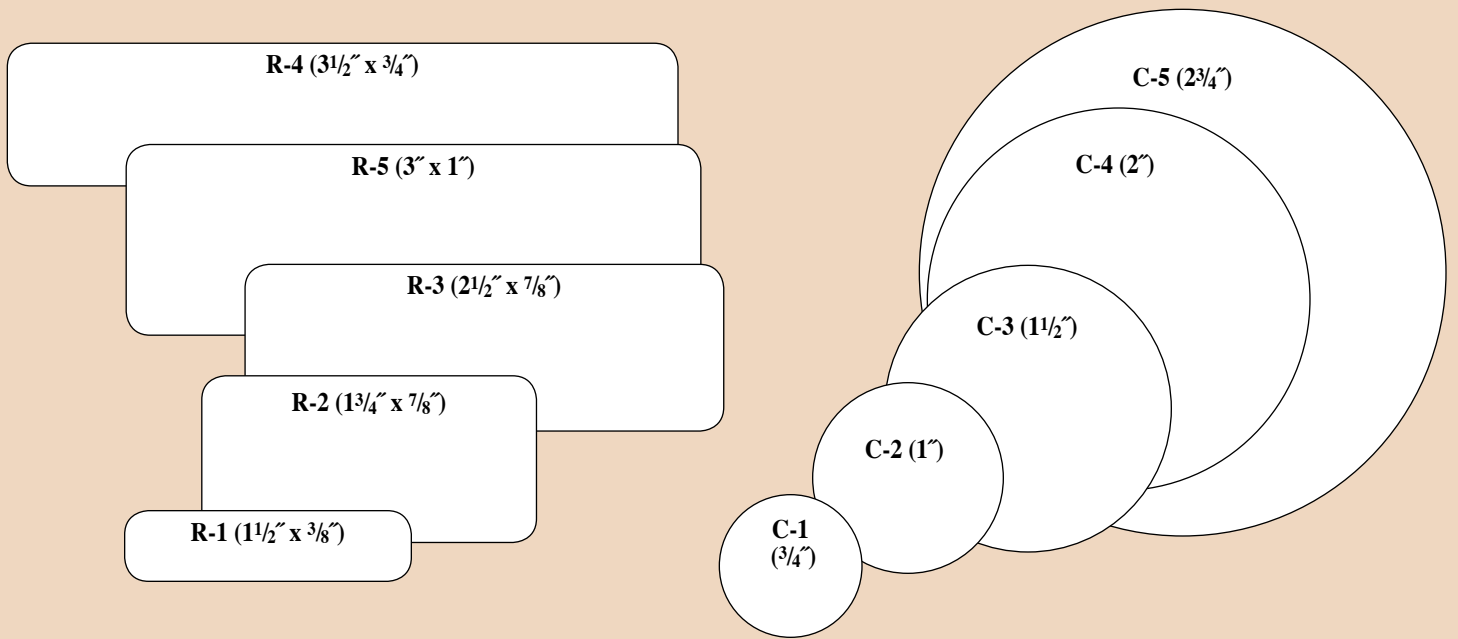

Pin Feed Printer Labels

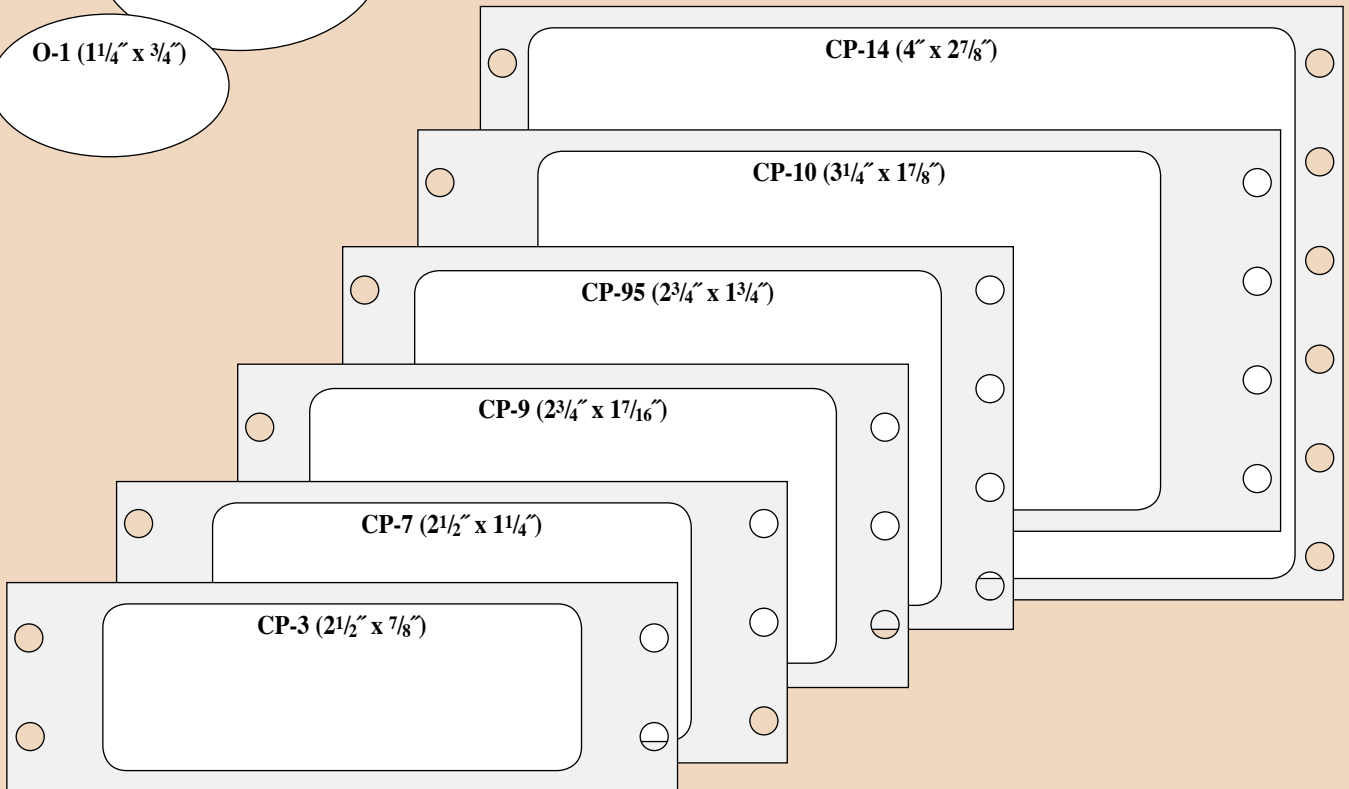

ORDER NOW